

CROSLEY

CR49

Traveler

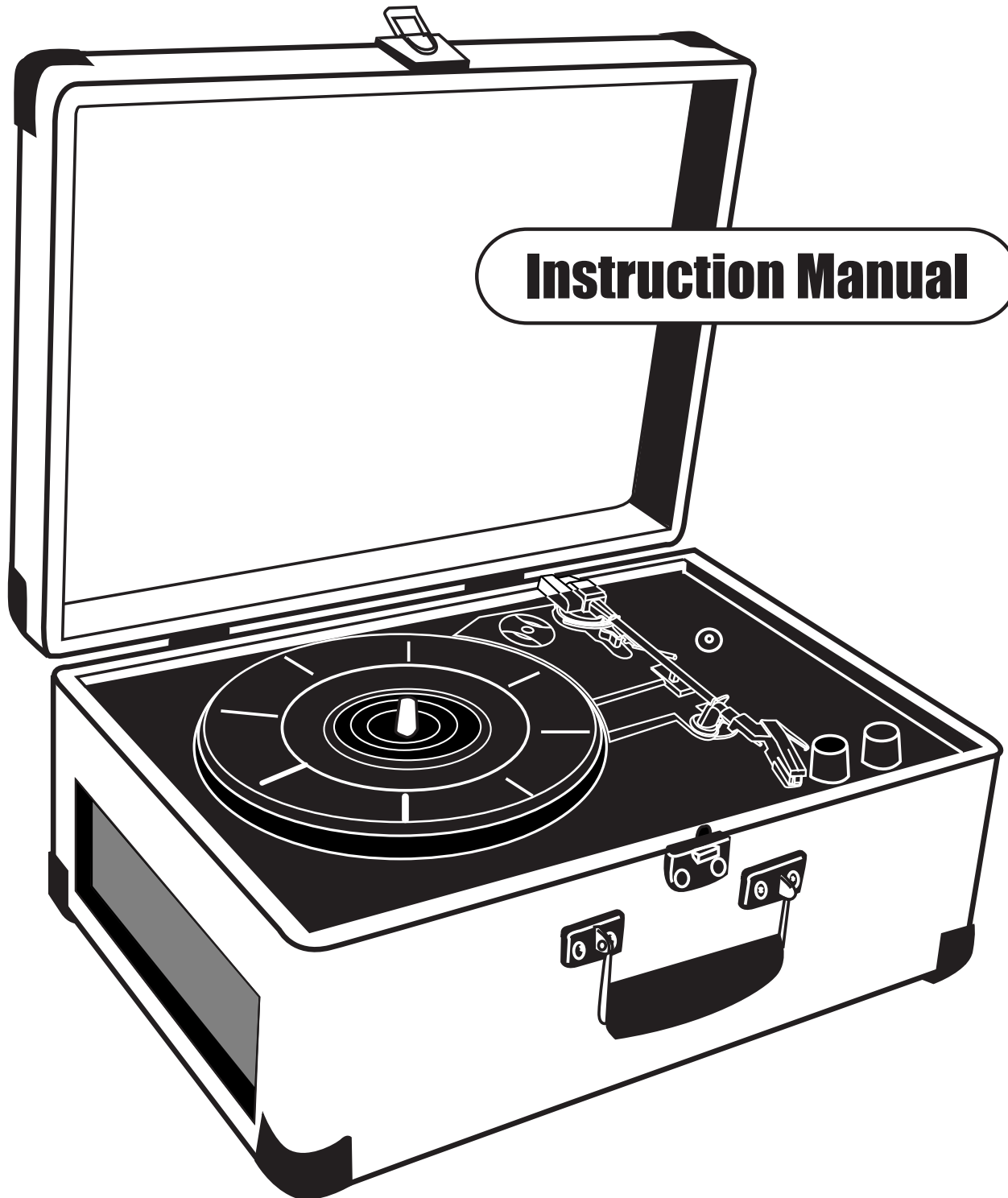

www.crosleyradio.com

IMPORTANT SAFETY INSTRUCTION

PLEASE READ CAREFULLY ALL THE FOLLOWING IMPORTANT SAFEGUARDS THAT ARE APPLICABLE TO YOUR EQUIPMENT

1. Read Instructions - All the safety and operating instructions should be read before the product is operated.
2. Retain instructions - The safety and operating instructions should be retained for future reference.
3. Heed Warnings - All warnings on the product and in the operating Instructions should be adhered to.
4. Follow Instructions - All operating and use instructions should be followed.
5. Cleaning - Unplug this product from the wall outlet before cleaning. Do not use liquid cleaners or aerosol cleaners. Use a damp cloth for cleaning.
6. Attachments - Do not use attachments not recommended by the product manufacturer as they may cause hazards.
7. Water and Moisture - Do not use this product near water - for example, near a bath tub, wash bowl, kitchen sink, or laundry tub; in a wet basement; or near a swimming pool; and the like.
8. A product and cart combination should be moved with care. Quick stops, excessive force, and uneven surfaces may cause the product and cart combination to overturn.
9. Ventilation - Slots and openings in the cabinet are provided for ventilation and to ensure reliable operation of the product and to protect it from overheating, and these openings must not be blocked or covered. The openings should never be blocked by placing the product on a bed, sofa, rug, or other similar surface. This product should not be placed in a built-in installation such as a bookcase or rack unless proper ventilation is provided or the manufacturer's instructions have been adhered to.
10. Power Sources - This product should be operated only from the type of power source indicated on the marking label, if you are not sure of the type of power supply to your home. Consult your product dealer or local power company. For products intended to operate from battery power, or other sources, refer to the operating instructions.
11. Grounding or Polarization - This product may be equipped with a polarized alternating-current line plug (a plug having one blade wider than the other). This plug will fit into the power outlet only one way. This is a safety feature. If you are unable to insert the plug fully into the outlet try reversing the plug. If the plug should still fail to fit, contact your electrician to replace your obsolete outlet. Do not defeat the safety purpose of the polarized plug.
12. Power - Cord Protection - Power - supply cords should be routed so that they are not likely to be walked on or pinched by items placed upon or against them, paying particular attention to cords at plugs, convenience receptacles, and the point where they exit from the product.
13. Lightning - For added protection for this product during a lightning storm, or when it is left unattended and unused for long periods of time, unplug it from the wall outlet and disconnect the antenna or cable system. This will prevent damage to the product due to lightning and power - line surges.
14. Power Lines - An outside antenna system should not be located in the vicinity of overhead power lines or other electric light or power circuits, or where it can fall into such power lines or circuits. When installing an outside antenna system, extreme care should be taken to keep from touching such power lines or circuits as contact with them might be fatal.
15. Overloading - Do not overload wall outlets, extension cords, or integral convenience receptacles as this can result in a risk of fire or electric shock.
16. Object and Liquid Entry - Never push objects of any kind into this product through openings as they may touch dangerous voltage points or short - out parts that could result in a fire or electric shock. Never spill liquid of any kind on the product.
17. Servicing - Do not attempt to service this product yourself as opening or removing covers may expose you to dangerous voltage or other hazards. Refer all servicing to qualified service personnel.
18. Damage Requiring Service - Unplug this product from the wall outlet and refer servicing to qualified service personnel under the following conditions;
 - a. When the power-supply cord or plug is damaged.
 - b. If liquid has been spilled, or objects have fallen into the product.
 - c. If the product has been exposed to rain or water.
 - d. If the product does not operate normally by following the operating instructions. Adjust only those controls that are covered by the operating instructions as an improper adjustment of other controls may result in damage and will often require extensive work by a qualified technician to restore the product to its normal operation.
 - e. If the product has been dropped or damaged in any way.
 - f. When the product exhibits a distinct change in performance - this indicates a need for service.
19. Replacement Parts - When replacement parts are required, be sure the service technician has used replacement parts specified by the manufacturer or have the same characteristics as the original part. Unauthorized substitutions may result in fire, electric shock, or other hazards.
20. Safety Check - Upon completion of any service or repairs to this product, ask the service technician to perform safety checks to determine that the product is in proper operating condition.
21. Wall or ceiling Mounting - The product should be mounted to a wall or ceiling only as recommended by the manufacturer.
22. Heat - The product should be situated away from heat sources such as radiators. Heat registers, stoves, or other products (including amplifiers) that produce heat.

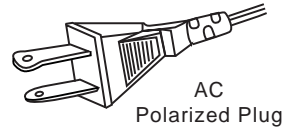

WARNING: Changes or modifications to this unit not expressly approved by the party responsible for compliance could void the user's authority to operate the equipment.

NOTE: This equipment has been tested and found to comply with the limits for a Class B digital device, pursuant to Part 15 of the FCC Rules. These limits are designed to provide reasonable protection against harmful interference in a residential installation. This equipment generates, uses, and can radiate radio frequency energy and, if not installed and used in accordance with the instructions, may cause harmful interference to radio communications. However, there is no guarantee that interference will not occur in a particular installation. If this equipment does cause harmful interference to radio or television reception, which can be determined by turning the equipment off and on, the user is encouraged to try to correct the interference by one or more of the following measures:

- Reorient or relocate the receiving antenna.
- Increase the separation between the equipment and receiver.
- Connect the equipment into a circuit different from that to which the receiver is connected.
- Consult the dealer or an experienced radio TV technician for help.

WARNING:

To reduce the risk of fire or electric shock, do not expose this appliance to rain or moisture.

CAUTION:

Use of controls or adjustments or performance of procedures other than those specified may result in hazardous radiation exposure.

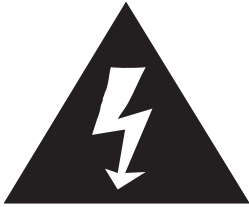

CAUTION
RISK OF ELECTRIC SHOCK
DO NOT OPEN



CAUTION:

TO REDUCE THE RISK OF ELECTRIC SHOCK, DO NOT REMOVE COVER (OR BACK). NO USER - SERVICEABLE PARTS INSIDE. REFER SERVICING TO QUALIFIED SERVICE PERSONNEL.

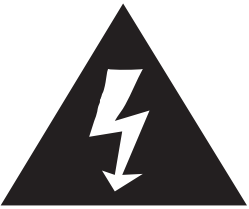

The lightning flash with arrowhead symbol, within an equilateral triangle, is intended to alert user to the presence of uninsulated "dangerous voltage" within the product's enclosure that may be of sufficient magnitude to constitute risk of electric shock to persons.



The exclamation point within an equilateral triangle is intended to alert user to the presence of important operating and maintenance (servicing) instruction in the literature accompanying the appliance.

Specification

Power Supply	: AC adapter -(DC 12V 0.5A)(Included)
Power Consumption	: 15W
Speed	: 33 ¹ / ₃ / 45 /78 RPM
Speaker	: 3 x 5" Dynamic Type x 2
Replacement Needle	: NP1

* DESIGN AND SPECIFICATIONS SUBJECT TO CHANGE WITHOUT NOTICE.

Welcome

Thank you for purchasing the Crosley Traveler (CR49). Before operating this unit, please read this manual thoroughly and retain it for future reference.

About This Manual

Instructions in this manual describe the control functions of the CR49.

Table of Contents

Getting Started

Unpacking.....	4
Power Source.....	4
Control Locators.....	5

Base Operation

Turntable Operation.....	6
Accessory: Adapter for 45 rpm	6

General

Troubleshooting Guide.....	7
Warranty.....	8

Getting Started

Unpacking

- 1 Remove packing materials from unit.
Note: Save all packing materials.
- 2 Remove plastic bag covering radio.
- 3 Remove plastic safety cover from A/C plug.
- 4 Open lid and remove styrofoam shipping material from turntable.
- 5 Remove black tie-wrap from under the tone arm.
- 6 Remove white protective needle cover by gently pulling towards the front of the unit.

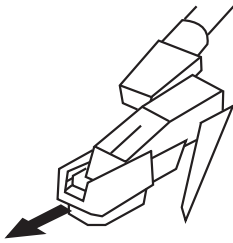

Set Up

- 1 Plug A/C adapter into appropriate outlet.



Note: This product may be equipped with a polarized alternating-current line plug (a plug having one blade wider than the other.) This plug will fit into the power outlet only one way. This is a safety feature. If you are unable to insert the plug fully into the outlet try reversing the plug, if the plug should still fail to fit, contact your electrician to replace your obsolete outlet. Do not defeat the safety purpose of the polarized plug.

Power Source

Unwind the A/C power adapter (located in a white box inside the packaging foam). Connect the small end of the adapter to the back of the turntable. Connect the other end to an A/C power outlet.

Control Locators

Unit Controls

LOCATION OF PARTS

1. ADAPTER FOR 45 RPM RECORD
2. CUE LEVER
3. TONE ARM
4. SPEED CONTROL SWITCH (33¹/₃, 45, 78 RPM)
5. POWER LIGHT INDICATOR
6. TONE ARM REST
7. SECURITY HOOK
8. TONE CONTROL
9. ON/OFF VOLUME KNOB
10. TURNTABLE
11. SPEAKER
12. ADAPTER JACK
13. AC ADAPTER (placed in a white cardboard box, location at on side of ploy-foam)

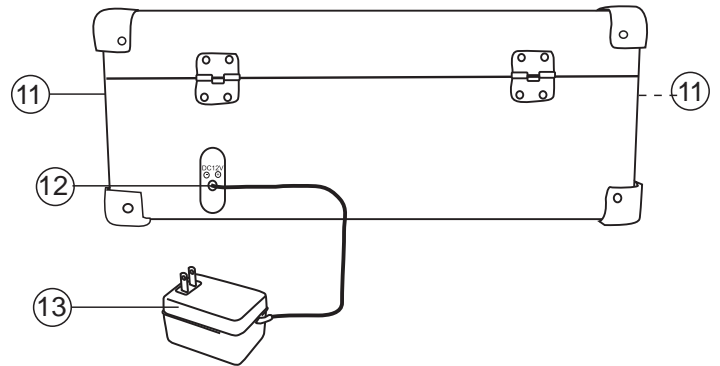
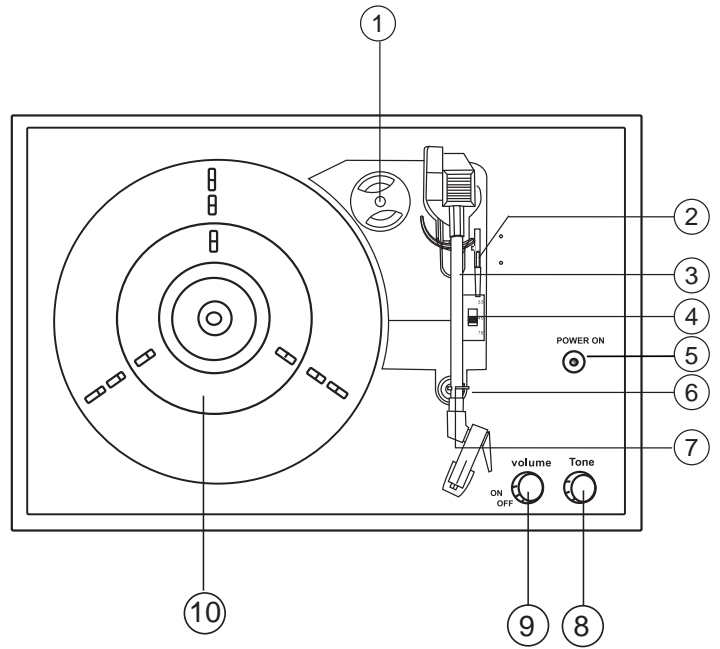

Turntable Operation

Turntable Operation

Turn the unit on by rotating the ON/OFF-VOLUME ROTARY KNOB (9) located on the front panel to the ON position.

- 1 Set the SPEED CONTROL SWITCH (4) to desire speed (33 1/3, 45 or 78 rpm). Place the record on the turntable.
- 2 Use the CUE LEVER (2) to raise the tone arm off its rest. Pull the TONE ARM (3) slightly to the right side until hear the "click" sound to activate the turntable.
- 3 Move the tone arm over the record and use the cue lever to lower it to the point you want the record to start. Adjust the ON/OFF-VOLUME ROTARY KNOB (9) to the desired listening level.
- 4 At the end of the record, the TONE ARM (3) will stop automatically. You must return to TONE ARM to arm rest by hand.

Accessory: ADAPTER FOR 45 RPM

This adaptor allows you to play 45 RPM records.

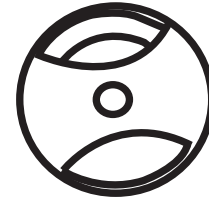

- 1 Place the 45 RPM adaptor over the spindle.
- 2 Gently place your 45 RPM record onto the turntable.
- 3 Follow the steps under turntable operation to play your record.

Troubleshooting

The unit does not operate.

- 1 The AC power cord is not connected to a power outlet.
- 2 The unit is not turned on : rotate the VOLUME knob from the OFF position

TURNTABLE

No sound is coming from unit.

- 1 The white protective needle cover was not removed.
- 2 The volume is not turned up.

Tone arm will not move.

- 1 Black tie-wrap was not removed from underneath tone arm
- 2 Tone arm hold down clip was not released.

LIMITED MANUFACTURERS WARRANTY

Crosley Radio, Inc. warrants the product to be free from defects in material and workmanship under normal use for a period of one year from the original date of purchase. This warranty is not transferable. If the product is determined to be defective during the warranty period, the unit will be repaired or replaced at Crosley Radio's sole discretion. This warranty covers manufacturing defects and normal consumer use and does NOT cover damage or failure as a result of abuse, accident, alterations, misuse, neglect, abnormal wear and tear, inadequate maintenance, commercial or unreasonable use, damage caused by power surges, mishandling, accident, acts of God or attempted repair by an unauthorized service agent. Also not covered are cosmetic damages, cords and antennas.

Should this product fail to function in a satisfactory manner, it is best to first return it to the store or retailer where it was originally purchased. If additional service is still needed, the original purchaser must **FIRST** contact our offices to obtain an RA (Return Authorization) Number.

TO OBTAIN AN RA NUMBER
CALL: **1.888.CROSLEY**
(1.888.276.7539)

Send the unit prepaid to the address below in the original packaging (or reasonable substitute to prevent damage). Clearly mark your RA number on the outside packaging and include the original sales receipt (or a copy) indicating date of purchase, amount paid, and place of purchase. You must also include your full name, shipping address and daytime contact number. Please include a check or money order in the amount of \$19.95, made payable to Crosley Radio, to cover handling and return shipping charges. Returned products will not be shipped to PO Boxes. Crosley Radio will not be responsible for delays or unprocessed claims resulting from a purchaser's failure to provide any or all of the necessary information.

CROSLEY RADIO
ATTN: RETURNS DEPT
2001 PRODUCTION DRIVE
Louisville, KY 40299

For additional support: Crosley Radio Consumer Service Department
24 hours a day / 7 days a week
Telephone: 1.888.CROSLEY (1.888.276.7539)

*There are no express warranties except as listed above.
The purchaser's bill of sale is the only proof of warranty entitlement.*

This warranty gives the purchaser specified legal rights in addition to any rights which may vary from state to state.

In accordance with the "Moss-Magnuson Warranty Act" of July 10, 1975, this is termed a "limited warranty" which in no way compromises Crosley Radio's high standards of quality and workmanship.